

No. CH-7

Unit : mm

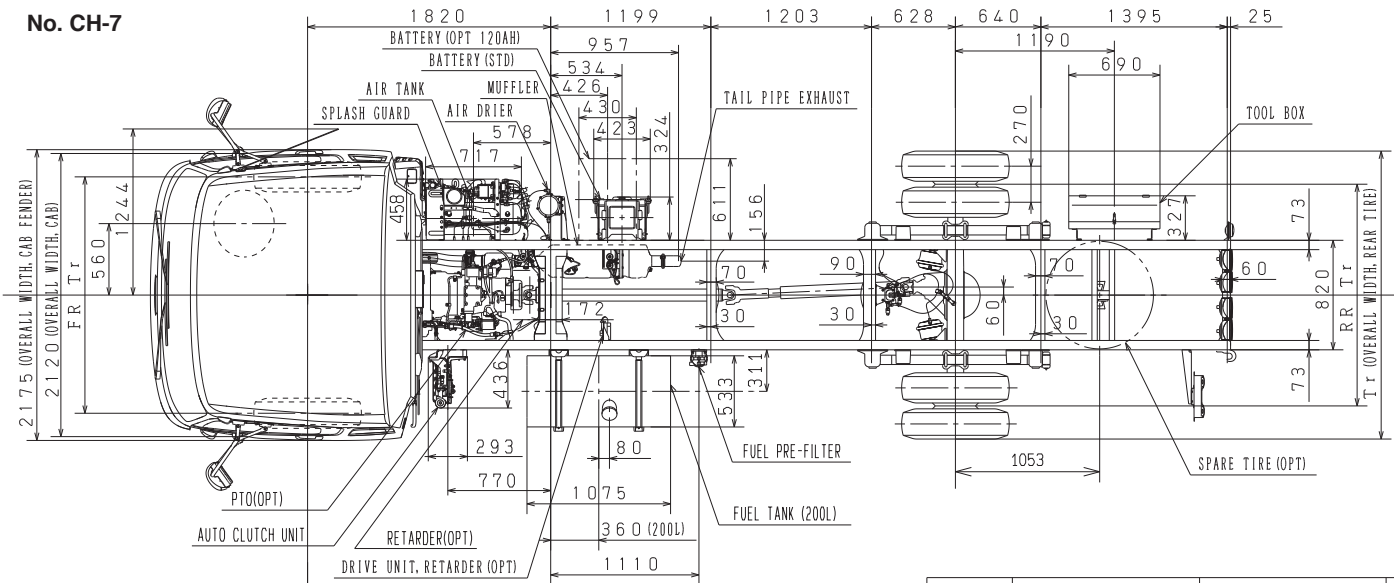

MODEL	TIRE	WHEEL	GROUND HEIGHT, FRAME UPPER SURFACE				FR Tr	RR Tr	Tr
			Hfo	Hf	Hr	Hro			
FD7JLMA	235/75R 17.5	17.5X6.75-135-9	740	765	855	895	1780	1660	2165

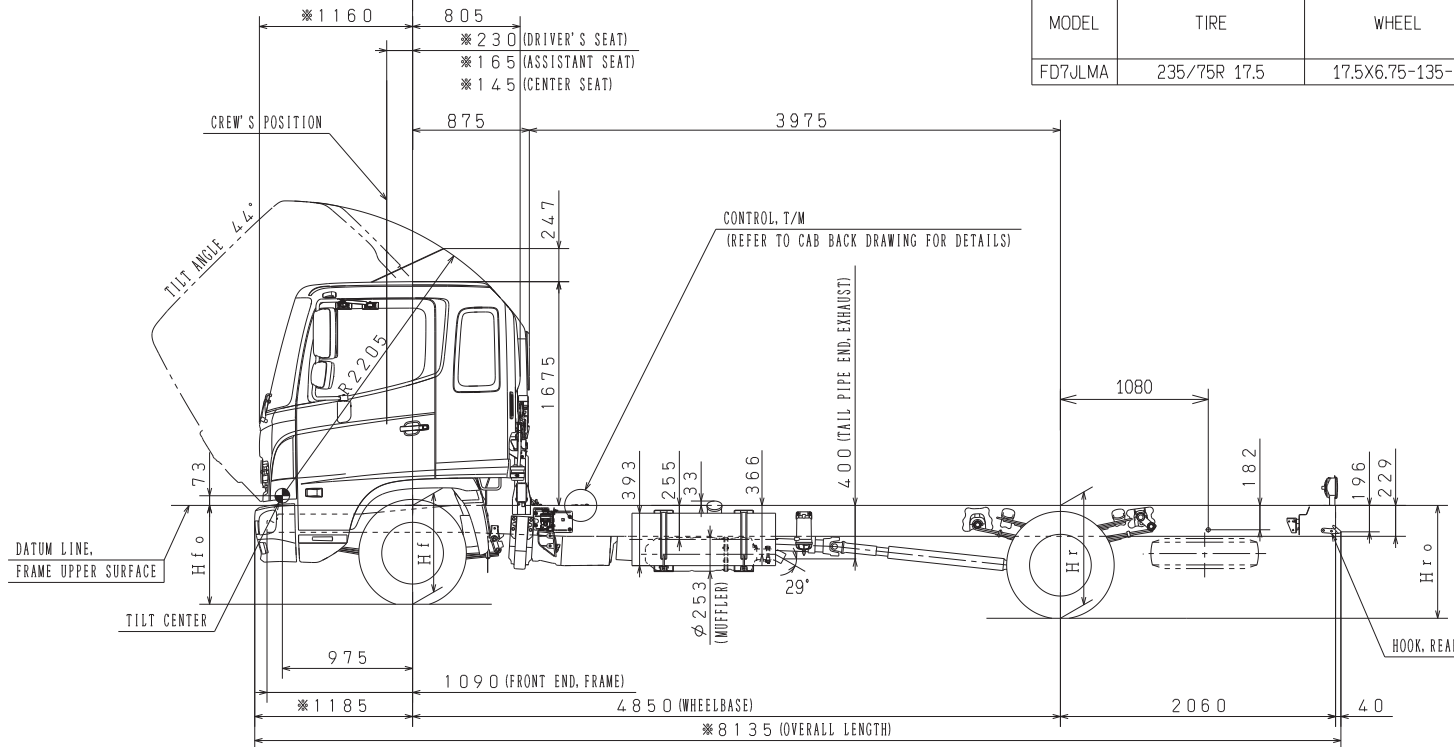

NOTE: 1. Figures marked "*" dimensions are measured in parallel with the surface of the ground.
 2. The dimension of tire to be mentioned in above table shows design figure according to JATMA or ETRTO standard.